



**LEARN MORE WITH
OUR HOW-TO VIDEOS**

www.youtube.com/FroniusSolar

Fronius Smart Meter TS 5kA-3

EN

Operating instructions

System monitoring



42,0426,0348,EN 009-18012021

Contents

Safety rules	5
Safety rules.....	7
Explanation of safety notices.....	7
General.....	7
Environmental conditions.....	8
Qualified personnel.....	8
Copyright.....	8
Data protection.....	8
General information	9
Fronius Smart Meter TS 5kA-3.....	11
Device description.....	11
Information on the device.....	12
Intended use.....	12
Scope of supply.....	13
Positioning.....	13
Measuring accuracy.....	14
Installation	15
Installation.....	17
Checklist for installation.....	17
Installation.....	18
Protective circuit.....	18
Auxiliary power supply cabling.....	18
Cabling.....	19
Selection criteria for current transformer.....	21
Connecting the current transformers.....	22
Suitable voltage transformers.....	22
Connecting the data communication cable to the inverter.....	22
Terminating resistors - Explanation of symbols.....	23
Connecting the terminating resistor.....	24
Terminating resistors.....	24
Mounting the connection cover.....	25
Multi-meter system - Explanation of symbols.....	26
Multi-meter system.....	26
Menu structure and parameters.....	27
Setting the transformation ratio of the current and voltage transformers.....	29
Setting the address on the Fronius Smart Meter TS.....	30
Start-up	31
Fronius SnapINverter.....	33
General.....	33
Connecting to the Fronius Datamanager.....	33
Configuring the Fronius Smart Meter TS as the primary meter.....	33
Configuring the Fronius Smart Meter TS as a secondary meter.....	34
Fronius GEN24 inverter.....	35
General.....	35
Installation using the web browser.....	35
Configuring the Fronius Smart Meter TS as the primary meter.....	36
Configuring the Fronius Smart Meter TS as a secondary meter.....	36
Technical data.....	37
Technical data.....	37
Fronius manufacturer's warranty.....	39

Safety rules

Safety rules

Explanation of safety notices

DANGER!

Indicates **immediate danger**.

- ▶ If not avoided, death or serious injury will result.

WARNING!

Indicates a **potentially hazardous situation**.

- ▶ If not avoided, death or serious injury may result.

CAUTION!

Indicates a **situation where damage or injury could occur**.

- ▶ If not avoided, minor injury and/or damage to property may result.

NOTE!

Indicates a **risk of flawed results and possible damage to the equipment**.

General

The device has been manufactured in line with the state of the art and according to recognized safety standards. If used incorrectly or misused, however, it can cause:

- Injury or death to the operator or a third party
- Damage to the device and other material assets belonging to the operating company.

All personnel involved in commissioning, maintenance, and servicing of the device must:

- Be suitably qualified
- Have knowledge of and experience in dealing with electrical installations and
- Have fully read and precisely followed these Operating Instructions

The Operating Instructions must always be at hand wherever the device is being used. In addition to the Operating Instructions, attention must also be paid to any generally applicable and local regulations regarding accident prevention and environmental protection.

All safety and danger notices on the device:

- Must be kept in a legible state
- Must not be damaged
- Must not be removed
- Must not be covered, pasted or painted over

The terminals can reach high temperatures.

Only operate the device when all protection devices are fully functional. If the protection devices are not fully functional, there is a danger of:

- Injury or death to the operator or a third party
- Damage to the device and other material assets belonging to the operating company

Any safety devices that are not fully functional must be repaired by an authorised specialist before the device is switched on.

Never bypass or disable protection devices.

For the location of the safety and danger notices on the device, refer to the section headed "General remarks" in the Operating Instructions for the device.

Any equipment malfunctions which might impair safety must be remedied before the device is turned on.

This is for your personal safety!

Environmental conditions

Operation or storage of the device outside the stipulated area will be deemed as not in accordance with the intended purpose. The manufacturer accepts no liability for any damage resulting from improper use.

Qualified personnel

The servicing information contained in these operating instructions is intended only for the use of qualified service engineers. An electric shock can be fatal. Do not carry out any actions other than those described in the documentation. This also applies to qualified personnel.

All cables and leads must be secured, undamaged, insulated and adequately dimensioned. Loose connections, scorched, damaged or inadequately dimensioned cables and leads must be immediately repaired by authorised personnel.

Maintenance and repair work must only be carried out by an authorised specialist.

It is impossible to guarantee that bought-in parts are designed and manufactured to meet the demands made on them, or that they satisfy safety requirements. Use only original spare parts (also applies to standard parts).

Do not carry out any alterations, installations, or modifications to the device without first obtaining the manufacturer's permission.

Components that are not in perfect condition must be changed immediately.

Copyright

Copyright of these operating instructions remains with the manufacturer.

The text and illustrations are all technically correct at the time of printing. We reserve the right to make changes. The contents of the operating instructions shall not provide the basis for any claims whatsoever on the part of the purchaser. If you have any suggestions for improvement, or can point out any mistakes that you have found in the instructions, we will be most grateful for your comments.

Data protection

The user is responsible for the safekeeping of any changes made to the factory settings. The manufacturer accepts no liability for any deleted personal settings.

General information

Fronius Smart Meter TS 5kA-3

Device description

The Fronius Smart Meter TS is a bidirectional electricity meter which optimises self-consumption and records the household's load curve. In conjunction with the Fronius inverter, Fronius Datamanager and Fronius data interface, the Fronius Smart Meter TS provides a clear overview of a user's own power consumption.

The meter measures the power flow to the loads or to the grid and forwards the information via the Modbus RTU/RS485 communication to the Fronius inverter and the Fronius Datamanager.



CAUTION!

Observe and follow safety instructions!

Failure to observe the safety instructions will result in damage to personnel and equipment.

- ▶ Switch off the power supply before establishing a mains connection.
 - ▶ Observe the safety instructions.
-

Information on the device

Technical data, markings and safety symbols are located on the Fronius Smart Meter TS. These must NOT be removed or painted over. They warn against incorrect operation which can lead to serious injury and damage.

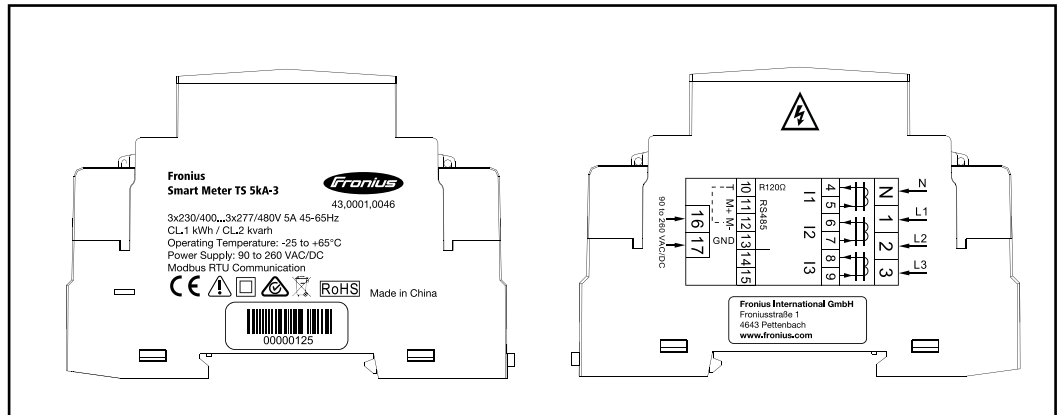

Markings:



The devices comply with all the requisite and relevant standards and guidelines that form part of the relevant EU Directive, and are therefore permitted to display the CE mark.



Insulated (protection class II)



Regulatory Compliance Mark (RCM)
Complies with all applicable regulatory requirements in Australia and New Zealand regarding safety and electromagnetic compatibility, as well as specific requirements for radio equipment.



To comply with European Directive 2012/19/EU on Waste Electrical and Electronic Equipment and its implementation as national law, electrical equipment that has reached the end of its life must be collected separately and returned to an approved recycling facility. Any device that you no longer require must be returned to your distributor or disposed of at an approved collection and recycling facility in your area. Ignoring this European Directive may have potentially adverse effects on the environment and your health!



RoHS (Restriction of Hazardous Substances)
The limited use of certain hazardous substances in electrical and electronic equipment has been complied with in accordance with EU Directive 2011/65/EU.

Safety symbols:



Risk of serious injury and property damage due to incorrect operation.



Dangerous electrical voltage.

Intended use

The Fronius Smart Meter TS is a fixed piece of equipment for public grids of TN/TT systems and records self-consumption and/or individual loads in the system. The Fronius Smart Meter TS is required for systems with a battery storage system and/or a Fronius Ohmpilot installed for communication between the individual components. The installa-

tion is carried out on an indoor DIN rail with corresponding back-up fuses, which are adapted to the cable cross-sections of the copper conductors and to the maximum current of the meter. The Fronius Smart Meter TS must only be operated in accordance with the specifications in the enclosed documentation and in accordance with local laws, regulations, provisions, standards and within the limits of technical possibilities. Any use of the product other than as described in the intended use shall be deemed to be not in accordance with the intended purpose. The available documentation forms part of the product and must be read, observed and kept in good condition. It must also be accessible at all times at the place of installation. The available documents do not replace regional, state, provincial or national laws, or regulations or standards that apply to the installation, electrical safety and use of the product. Fronius International GmbH assumes no responsibility for compliance with or non-compliance with these laws or regulations in connection with the installation of the product.

Interventions on the Fronius Smart Meter TS, e.g. modifications and alterations, are not permitted. Unauthorised interventions will void the warranty and warranty claims and, as a rule, void the user's authority to operate the equipment. The manufacturer shall not be liable for any damage resulting from such use.

Reasonably foreseeable misuse:

The Fronius Smart Meter TS is not suitable for the supply of life-sustaining medical devices or for the billing of subtenants.

Scope of supply

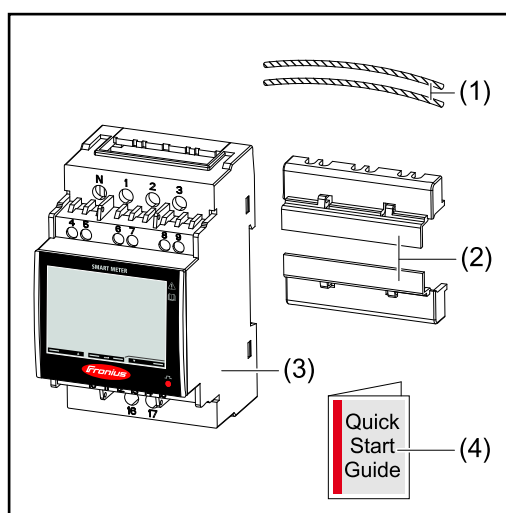

- (1) 2x seal wire
- (2) 2x connection cover
- (3) Fronius Smart Meter TS 5kA-3
- (4) Quick Start guide

Positioning

The Fronius Smart Meter TS can be installed in the following positions in the system:

Positioning at the feed-in point:

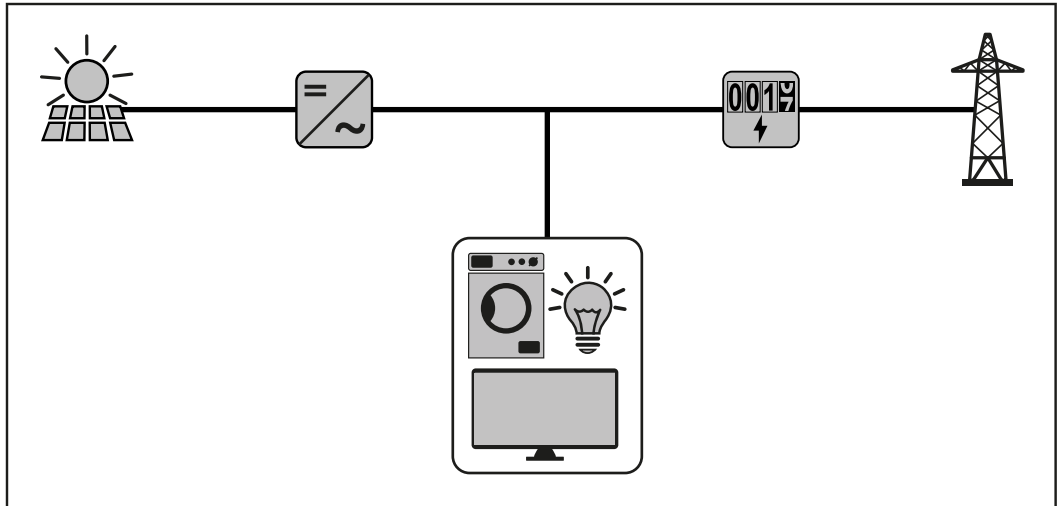

Positioning at consumption point:

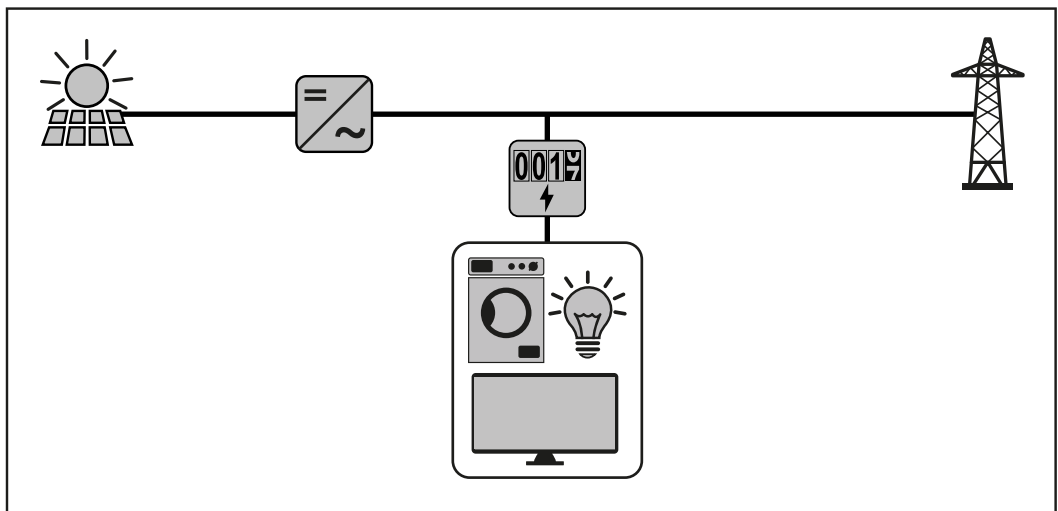

For use as a secondary meter to measure individual loads and producers, see chapter [Multi-meter system](#) on page [26](#).

Measuring accuracy

The Fronius Smart Meter TS has accuracy class 1 when measuring active energy (EN IEC 62053-21) in the voltage ranges 400 - 480 VLL or 230 -277 VLN. Within the voltage ranges 173 - 400 VLL or 100 - 230 VLN the accuracy class is 2 (active energy according to EN IEC 62053-21, reactive energy according to EN IEC 62053-23). For further details see [Technical data](#) on page [37](#).

Installation

Checklist for installation

For installation information, see the following chapters:

- 1 Switch off the power supply before establishing a mains connection.
- 2 Mount the Fronius Smart Meter TS (see [Installation](#) on page 18).
- 3 Connect automatic circuit breakers or automatic circuit breakers and disconnectors (see [Protective circuit](#) on page 18).
- 4 Connect the mains cable to the Fronius Smart Meter TS (see [Cabling](#) on page 19).
- 5 Mount the current transformers on the conductors. Make sure that the current transformers are pointing in the correct direction. An arrow either points to the load or the source (public grid) (see [Connecting the current transformers](#) on page 22).
- 6 Connect the current transformer and Fronius Smart Meter TS (see [Connecting the current transformers](#) on page 22).
- 7 Make sure that the current transformer phases match the mains voltage phases (see [Connecting the current transformers](#) on page 22).
- 8 Note down the nominal current of the current transformer for each meter. These values will be required during setup.
- 9 Connect the data communication connections of the Fronius Smart Meter TS to the Fronius system monitoring (see [Connecting the data communication cable to the inverter](#) on page 22).
- 10 If necessary, set terminating resistors (see [Connecting the terminating resistor](#) on page 24).
- 11 Tug on each wire and plug to make sure that they are securely connected to the terminal blocks.
- 12 Switch on the power supply to the Fronius Smart Meter TS.
- 13 Check the firmware version of the Fronius system monitoring. To ensure compatibility between the inverter and the Fronius Smart Meter TS, the software must always be kept up to date. The update can be started via the inverter web page or using Solar.web.
- 14 Set the transformation ratio of the current and voltage transformers (see [Setting the transformation ratio of the current and voltage transformers](#) on page 29).
- 15 If several Fronius Smart Meter TS are installed in the system, set the address (see "Setting the address" under [Setting the address on the Fronius Smart Meter TS](#) on page 30).
- 16 Configure and commission the meter (see [Start-up](#) on page 31).

Installation

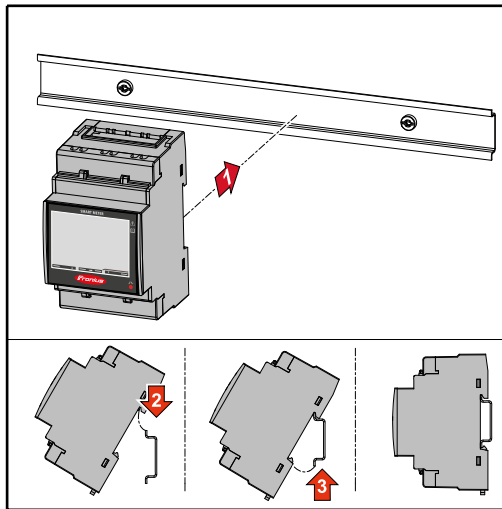

The Fronius Smart Meter TS can be mounted on a 35 mm DIN rail. The housing comprises 3 modules according to DIN 43880.

Protective circuit

The Fronius Smart Meter TS is a hard-wired device and requires a disconnecting device (circuit breaker, switch or disconnector) and overcurrent-protection (automatic-circuit breaker).

The Fronius Smart Meter TS consumes 10 - 30 mA, the nominal capacity of the disconnecting devices and the overcurrent-protection is determined by the wire thickness, the mains voltage and the required breaking capacity.

- Disconnecting devices must be mounted within sight and as close as possible to the Fronius Smart Meter TS; they must also be easy to use.
- The disconnecting devices must satisfy the requirements of IEC 60947-1 and IEC 60947-3, as well as all national and local regulations for electrical systems.
- To monitor more than one mains voltage, use connected-automatic circuit breakers.
- The overcurrent-protection must protect the mains terminals with the designations L1, L2 and L3. In rare cases, the neutral conductor has an overcurrent-protection, which must interrupt both neutral and non-earthed cables concurrently.

Auxiliary power supply cabling

IMPORTANT!

An auxiliary power supply is required to operate the Fronius Smart Meter TS. The fuse (F) must comply with the national standards and guidelines as well as the dimensions of the conductors.

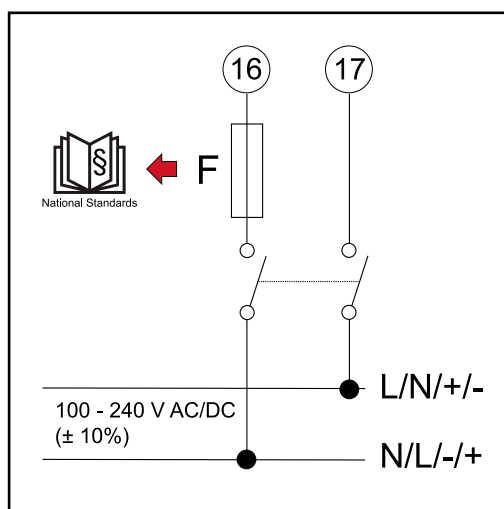

Cabling

IMPORTANT!

Always switch off the power supply before connecting the mains voltage inputs to the Fronius Smart Meter TS.

Recommended thickness of stranded mains voltage cables for the terminals of the measuring input and measuring output:

- Wire: 1 - 4 mm²
- Recommended torque: max. 0.6 Nm

The measuring inputs of the current transformers must be be earthed on one side as shown in the circuit diagram.

Connect each voltage cable to the terminal strip as shown in the graphics below.

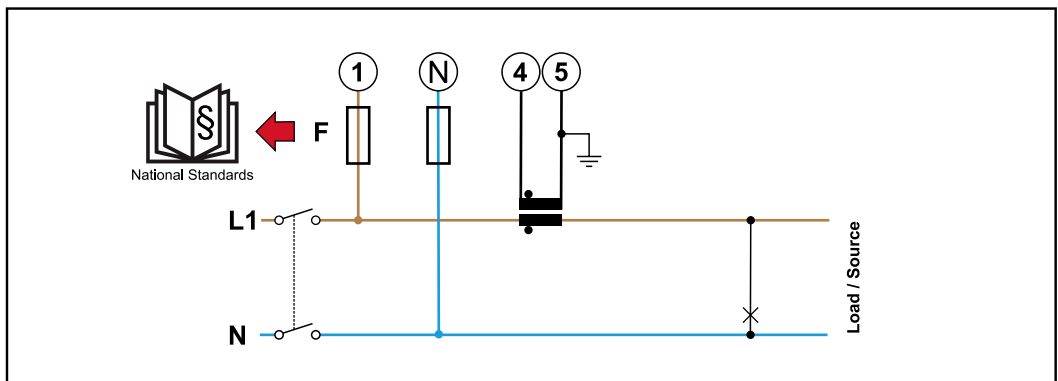

1 phase, 2 conductors (CT connection)

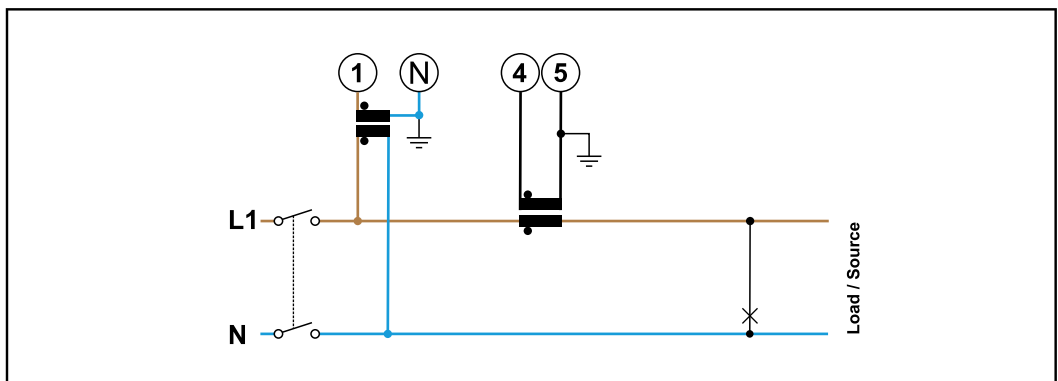

1 phase, 2 conductors (VT/CT connection)

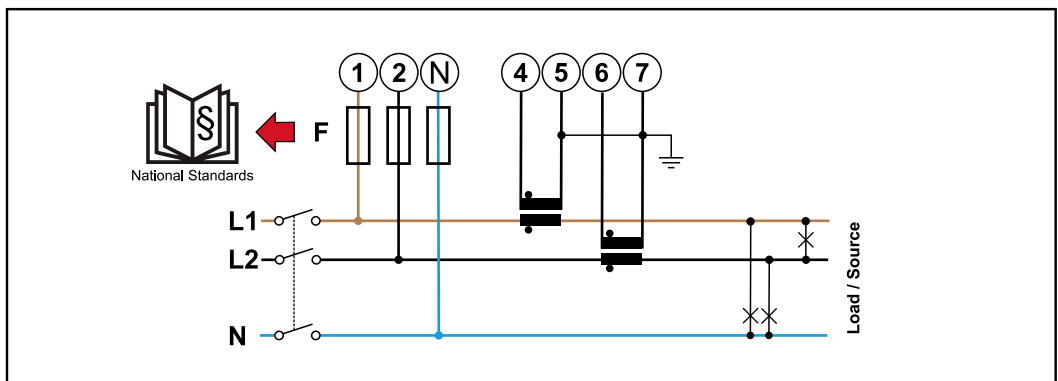

2 phases, 3 conductors (CT connection)

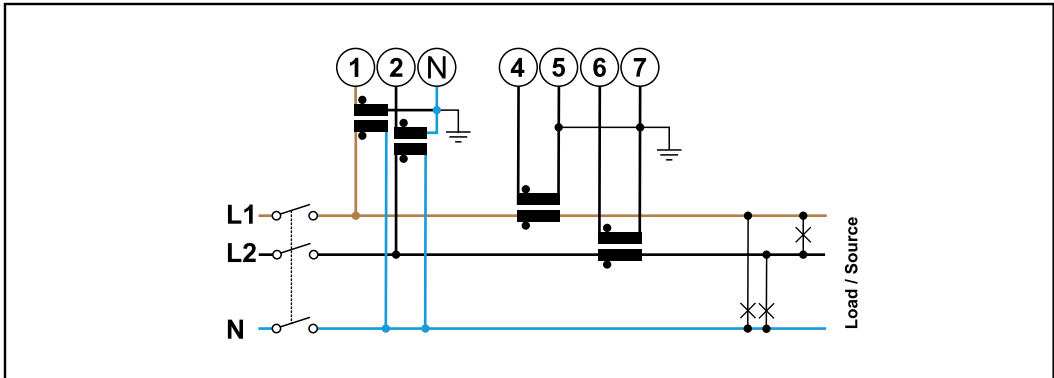

2 phases, 3 conductors (VT/CT connection)

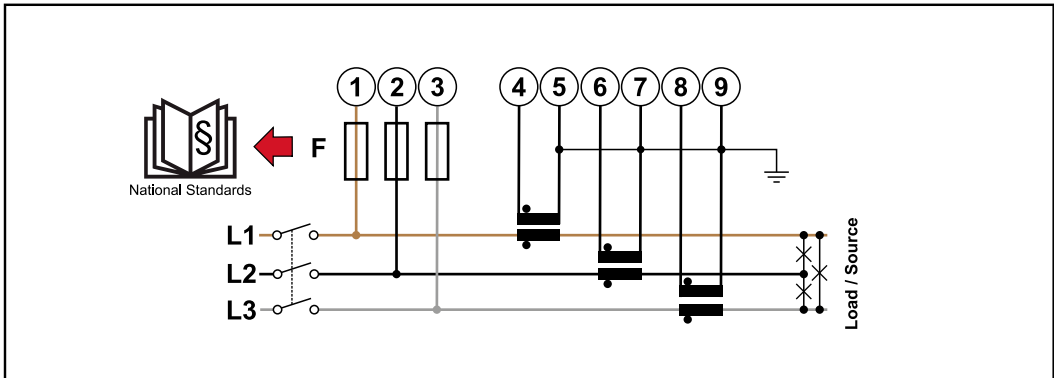

3 phases, 3 conductors (CT connection)

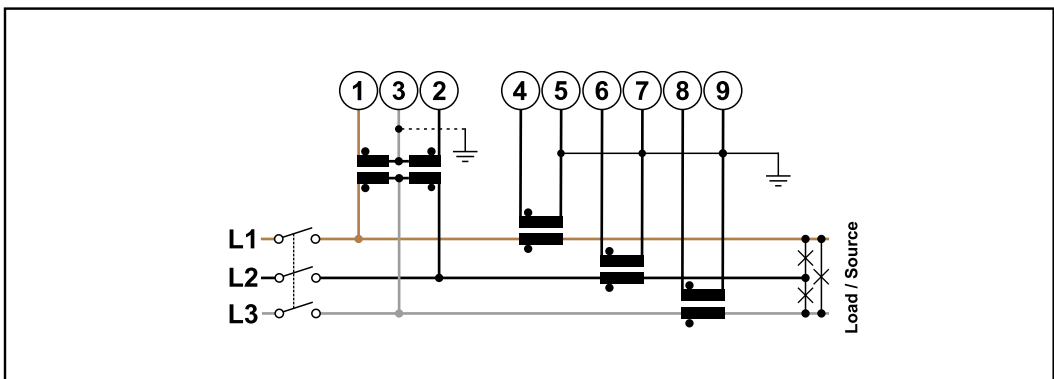

3 phases, 3 conductors (VT/CT connection)

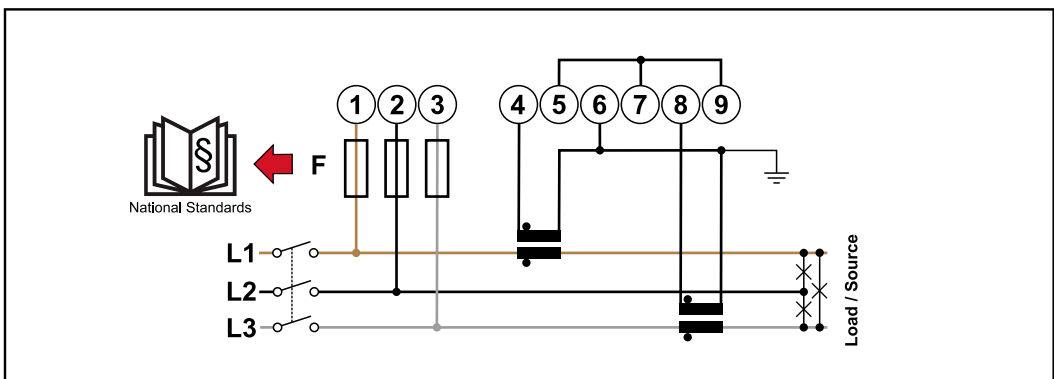

3 phases, 4 conductors (Aron CT connection)

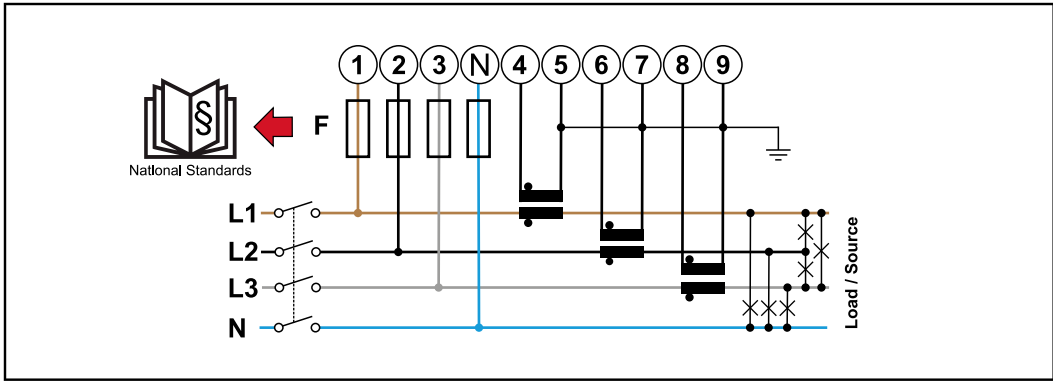

3 phases, 4 conductors (CT connection)

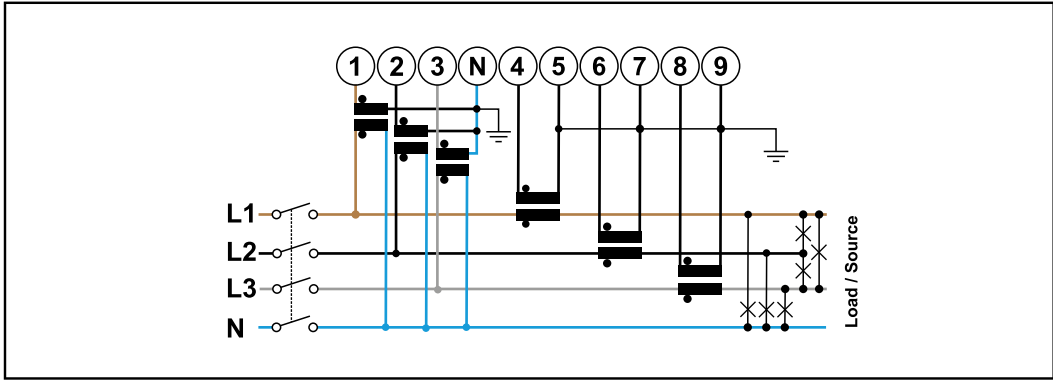

3 phases, 4 conductors (VT/CT connection)

Selection criteria for current transformer

General

Do not use current transformers with a voltage output. Current transformers are directional. If they are mounted backwards or with swapped wires, the measured power will be negative.

Primary current

Maximum current per phase. A current converter with a primary current greater than the maximum expected current per phase should be selected. The closer the expected current is to this value, the more precise the measurement will be.

Secondary current

The current transformer must supply alternating current at a nominal current of 1 or 5 A. The nominal values for the current transformer are listed in the current transformer data sheet.

Power

The Fronius Smart Meter TS needs 0.5 VA to carry out its measurements. Losses also occur on the outgoing and return leads. The power of the current converter must be greater than the sum total of the power of the Fronius Smart Meter TS and the leads. The higher the power, the better.

Line resistances at different cross-sections (copper wires)						
Secondary current [A]	Cross-section [mm ²]	Line resistances at different lead lengths (outgoing and return lead)				
		0.5 m	1.0 m	2.5 m	5 m	10 m
5	1.5	0.3 VA	0.6 VA	1.5 VA	2.9 VA	5.8 VA
5	2.5	0.2 VA	0.4 VA	0.9 VA	1.8 VA	3.6 VA

Line resistances at different cross-sections (copper wires)						
Secondary current [A]	Cross-section [mm ²]	Line resistances at different lead lengths (outgoing and return lead)				
		0.5 m	1.0 m	2.5 m	5 m	10 m
5	4	-	-	0.6 VA	1.1 VA	2.2 VA

Example

The length of the outgoing and return lead (0.5 m each) between the Fronius Smart Meter TS and the current transformer is a total of 1 m and has a copper cable cross-section of 1.5 mm²; the line resistance is therefore 0.6 VA according to the table above. The self-consumption of the Fronius Smart Meter TS is 0.5 VA.

Line resistance 0.6 VA + self-consumption 0.5 VA = 1.1 VA

→ A current transformer with a rating of 1.5 VA, 5 VA or higher is suitable here.

Accuracy class

Use Class 1 or better (Class 0.5 / 0.2, etc.). Class 1 is equivalent to a deviation of ± 1% of the secondary current at maximum power.

Mounting

Rigid or hinged

"Rigid" is usually cheaper with better power and accuracy values. Hinged current transformers can be opened for attachment to the conductor. To prevent it being opened inadvertently, a plastic cable tie can be secured to the current transformer. Hinged current transformers can be installed in a system without interrupting the voltage.

Connecting the current transformers

- 1 Make sure that the current transformers match the voltage phases. Make sure that current transformer L1 measures the current on the same phase that is monitored by voltage input L1. The same applies for phases L2 and L3.
- 2 Make sure that the current transformers are pointing in the correct direction. Observe the data sheet for the current transformer.
- 3 Note down the nominal current of the current transformer for each meter. These values will be required for setup.
- 4 Attach the current transformers to the conductor to be measured and connect the cables of the current transformer to the Fronius Smart Meter TS.

IMPORTANT!

Always switch off the power supply before disconnecting live conductors.

- 5 The current transformers are connected to connections 4 and 5; 6 and 7; 8 and 9. If necessary, excessively long cables can be shortened accordingly. Observe the sequence in which the phases are connected. Accurate power measurement is only ensured if the mains voltage phases match the current phases.

Suitable voltage transformers

Only voltage transformers with a voltage range from 220 to 480 V (phase - phase) and from 100 to 277 V (phase - neutral conductor) may be used. The voltage transformers must be connected to terminals 1, 2, 3 and N at the point of direct voltage measurement.

Connecting the data communication cable to the inverter

Connect the data communication connections of the Fronius Smart Meter TS to the Modbus interface of the Fronius inverter using a network cable (type CAT5 or higher).

Several Smart Meters can be installed in the system, see chapter [Multi-meter system](#) on page 26.

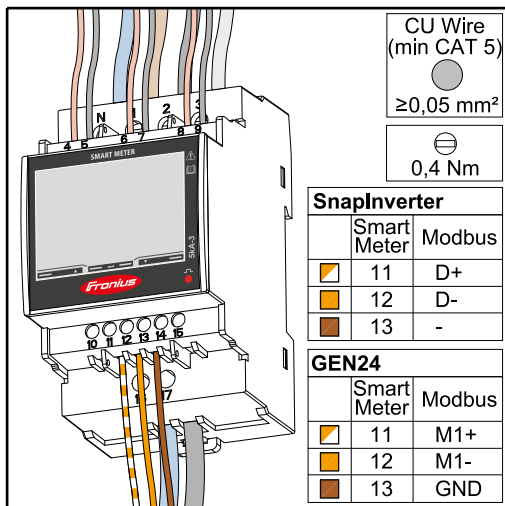

To avoid interference, the terminating resistor must be used (see chapter [Connecting the terminating resistor](#) on page 24).

IMPORTANT!

More information on successful commissioning.

Note the following information about connecting the data communication cable to the inverter.

- Use network cables of type CAT5 or higher.
- Use a mutual twisted cable pair for corresponding data lines (D+/D-, M1+/M1-).
- If the data lines are close to the mains cabling, use wires or cables that are designed for 300 to 600 V (never less than the operating voltage).
- Use double-insulated or sheathed data lines when they are close to bare conductors.
- Use shielded twisted pair cables to avoid faults.
- Two wires can be installed in each terminal; the wires are twisted first, inserted into the terminal and tightened.

Note: A loose wire can disable an entire area of the network.

- The data communication connections of the Fronius Smart Meter TS are electrically isolated from hazardous voltages.

Terminating resistors - Explanation of symbols



Inverter in the system

e. g. Fronius Symo



Meter - Fronius Smart Meter TS

Terminating resistor R 120 Ohm is set with a wire jumper between M- and T.

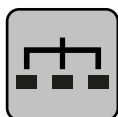

Modbus RTU slave

e. g. Fronius Ohmpilot, Fronius Solar Battery, etc.



Terminating resistor

R 120 Ohm

Connecting the terminating resistor

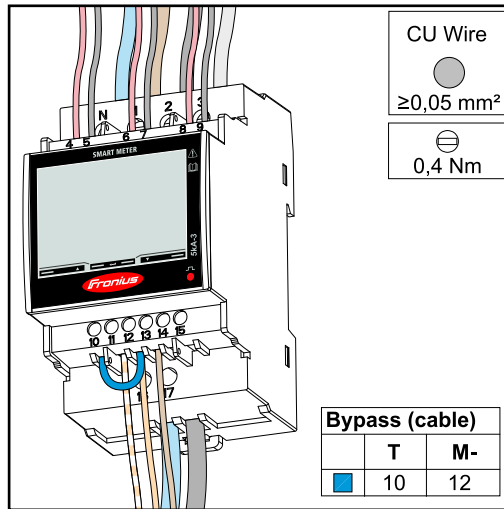

The terminating resistor is integrated in the Fronius Smart Meter TS and is manufactured with a bridge between the **M** and **T** connections (T = termination).

Terminating resistors

Due to interference, it is recommended that terminating resistors are used as illustrated below to ensure proper functioning.

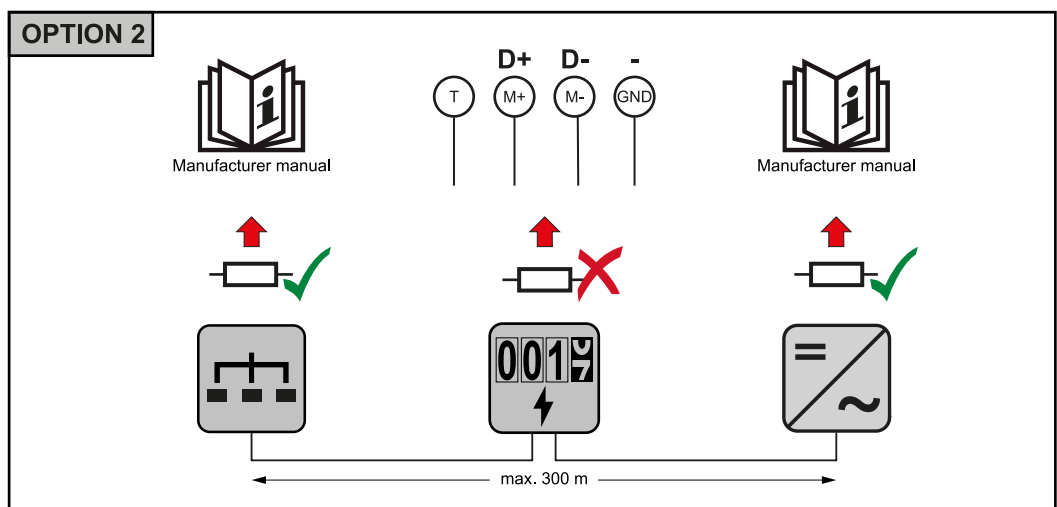
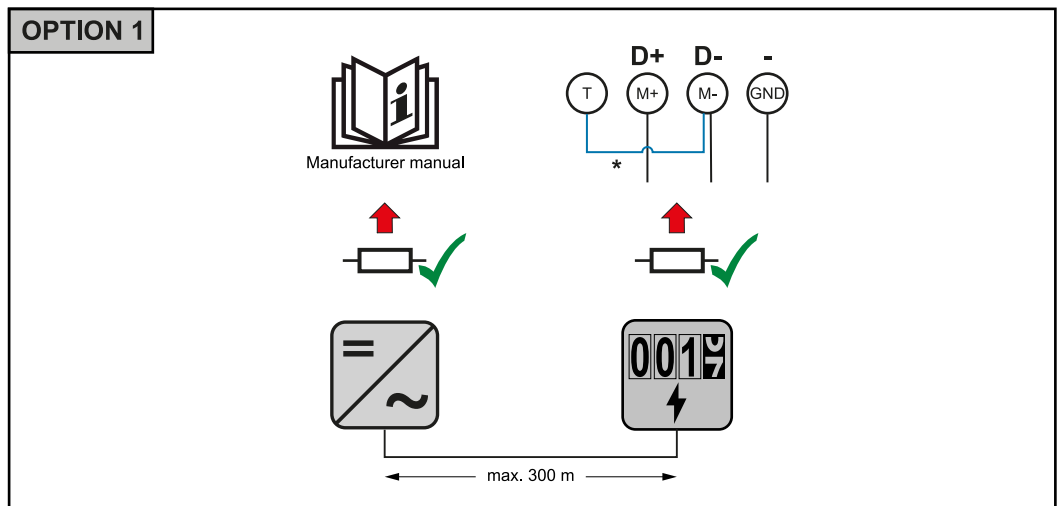

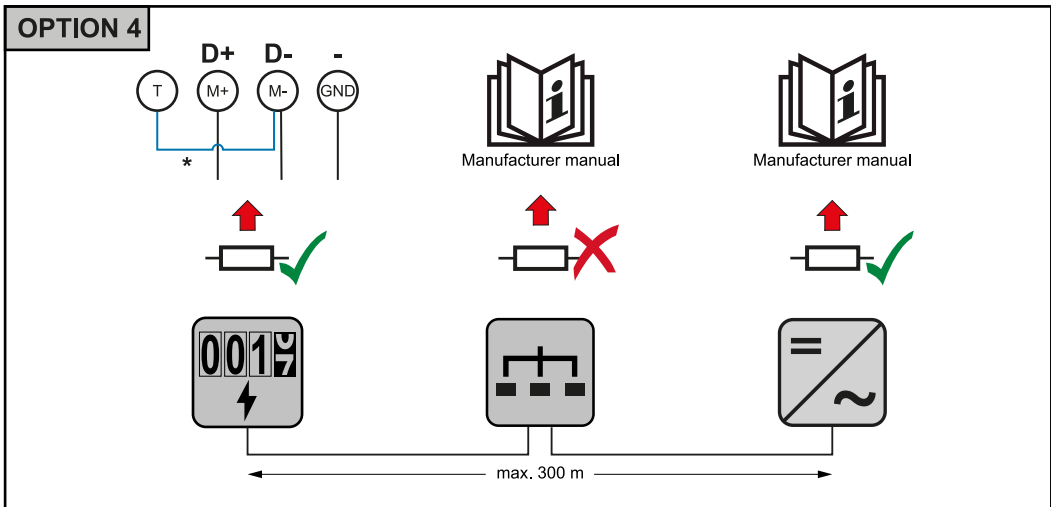
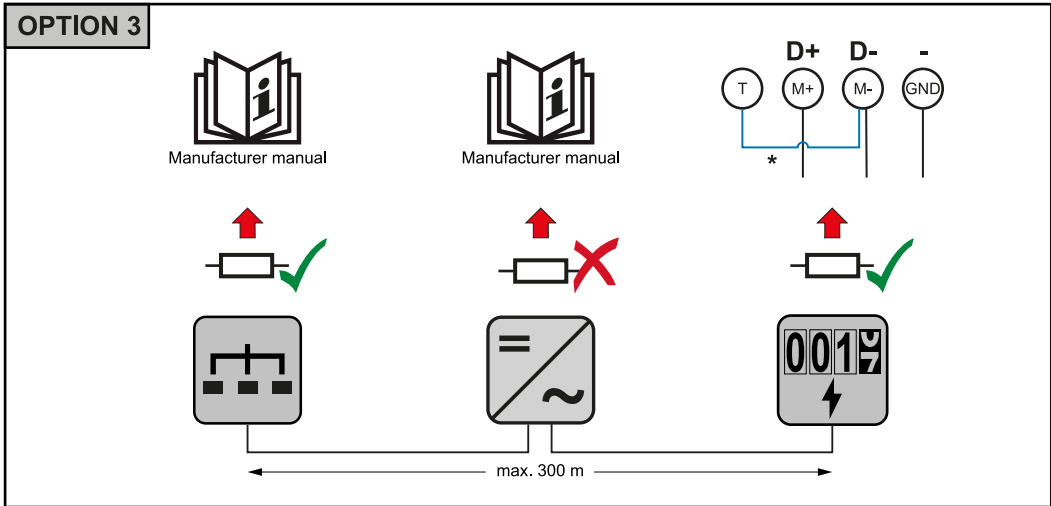

* The terminating resistor is integrated in the Fronius Smart Meter TS and is manufactured with a bridge between the **M** and **T** connections (T = termination).

Mounting the connection cover

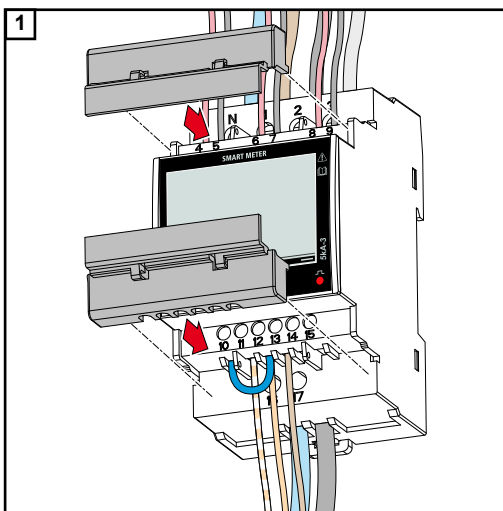

Insert the connection covers into the guides and press firmly.

IMPORTANT!
When fitting the connection covers, ensure that the cables are not kinked, pinched, crushed or otherwise damaged.

Multi-meter system - Explanation of symbols

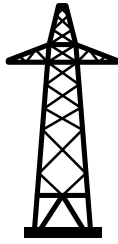

Grid

supplies the loads in the system if insufficient power is being generated by the solar modules or supplied by the battery.



Inverter in the system

e. g. Fronius Primo, Fronius Symo, etc.



Utility meter

Measures the measurement data relevant for billing amounts of energy (in particular kilowatt hours of energy sourced from the grid and energy fed into the grid). Based on the relevant billing data, the electricity retailer will invoice the energy sourced from the grid and the purchaser of the surplus energy will reimburse the energy fed into the grid.



Primary meter

Records the system's load curve and provides measurement data for energy profiling in Fronius Solar.web. The primary meter also controls the dynamic feed-in control.



Secondary meter

Records the load curve of individual loads (e.g. washing machine, lamps, TV, heat pump, etc.) in the consumption branch and provides measurement data for energy profiling in Fronius Solar.web.



Producer meter

Records the load curve of individual producers (e.g. wind power plant) in the consumption branch and provides measurement data for energy profiling in Fronius Solar.web.

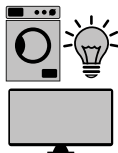

Loads in the system

e. g. washing machine, lamps, TV, etc.



Additional loads in the system

e. g. heat pump



Additional producers in the system

e. g. wind power plant



Terminating resistor

R 120 Ohm

Multi-meter system

If several Fronius Smart Meter TS are installed, a separate address must be set for each (see [Setting the address on the Fronius Smart Meter TS](#) on page 30). The primary meter is always assigned address 1. All the other meters are numbered consecutively

with the address range from 2 to 14. Different Fronius Smart Meter power categories can be used in combination.

IMPORTANT!

Max. Use 3 secondary meters in the system.

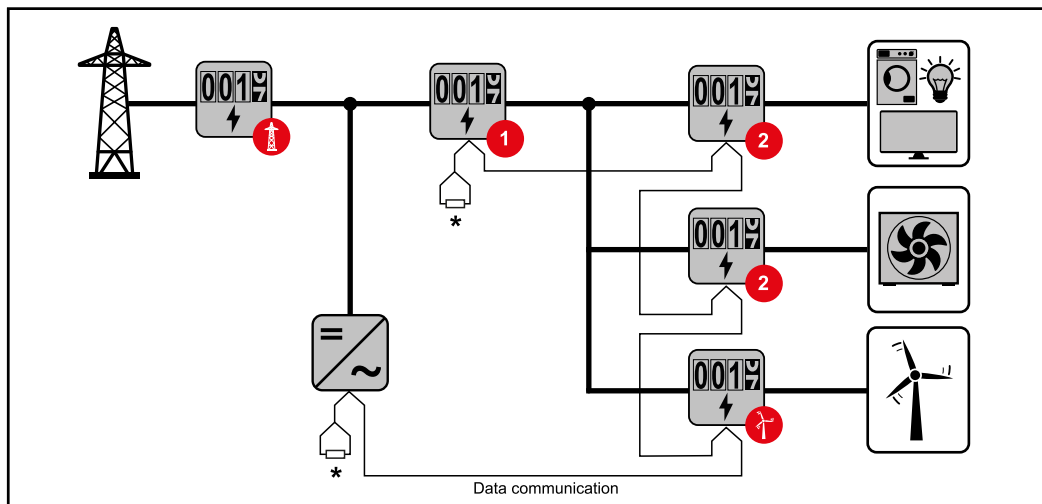

Location of the primary meter in the consumption branch. *Terminating resistor R 120 Ohm

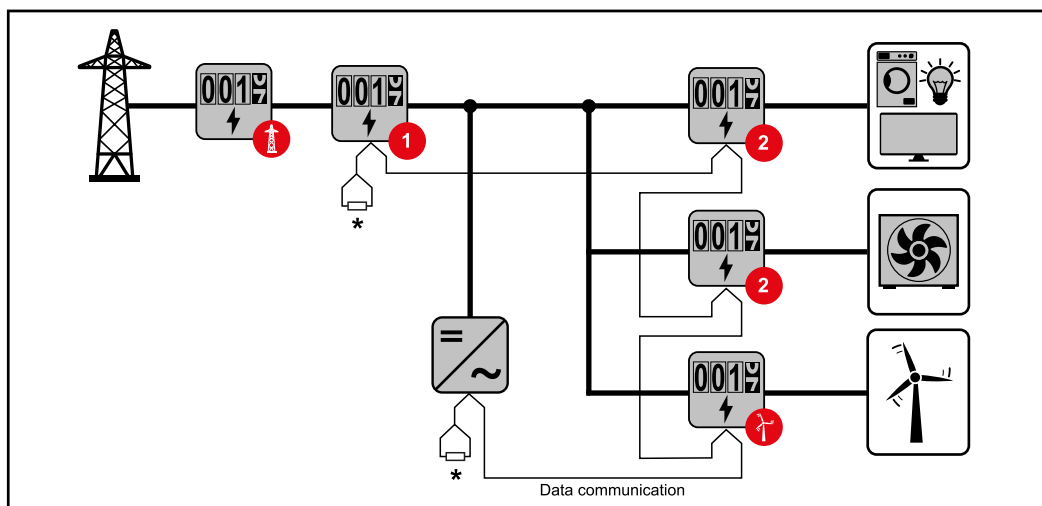

Location of the primary meter at the feed-in point. *Terminating resistor R 120 Ohm

The following must be observed in a multi-meter system:

- Only assign each Modbus address once.
- Terminating resistors must be positioned individually for each channel.

For PV systems with inverters from the Fronius GEN24 and Fronius Tauro product series, the following must be observed:

- The primary meter and the battery must be connected to different channels.
- The remaining Modbus participants must be distributed equally.

Menu structure and parameters

Screen	Code	Description	Values
PASS***	P1	Enter the current password	2633*
nPASS	P2	Password change **	Four digits (0000-9999)

Screen	Code	Description	Values
SYStEM	P3	Type of system	3Pn*: three-phase system, 4-core 3P: three-phase system, 3-core 2P: two-phase system, 3-core
Ct rAtlo	P4	Current transformer ratio	from 1* to 1000
Ut rAtlo	P5	Voltage transformer ratio	from 1* to 1000
MEASurE	P6	Measurement mode **	A: easy connection, measures all energy without taking the direction into account. B*: measures imported and exported energy separately.
InStALL	P7	Connection check	On: activated Off*: deactivated
P int	P8	Average power calculation interval (minutes)	1* - 30
MOdE	P9	Display mode **	Full*: full display Easy: reduced display. The values that are not displayed are still transmitted via the serial interface.
tArIFF	P10	Tariff management **	On: activated Off*: deactivated
HoME	P11	Screen showing measured variables displayed at startup and after 120 seconds of inactivity **	For full display (Mode = Full): 0* - 19
AddrESS** *	P14	Modbus address	1* - 247
bAUd	P15	Baud rate (kBit/s) **	9.6* / 19.2 / 38.4 / 57.6 / 115.2
PARITY	P16	Parity **	Even/No*
STOP bit	P16-2	Only if parity = No. Stop bit **	1* / 2
rESET	P17	Activation of the reset function for energy tariffs, maximum requested power and part values of active and reactive energy (the latter are only transmitted via the serial interface) **	No*: reset function deactivated. Yes: reset function activated.
End	P18	Returns to the measured variables start screen	None







* Factory settings

** The settings can be protected by changing the default password (password cannot be reset).

*** Settings that need to be configured.

Setting the transformation ratio of the current and voltage transformers

Only the transformation ratio of the current and voltage transformers must be set. All other parameters are preset at the factory.

Symbol	Name	Event	Function
	Up	1 x 	Scroll one screen forward, increase the value by 1
	Down	1 x 	Scroll one screen back, decrease the value by 1
	Enter	2 seconds 	Call up settings, confirm value

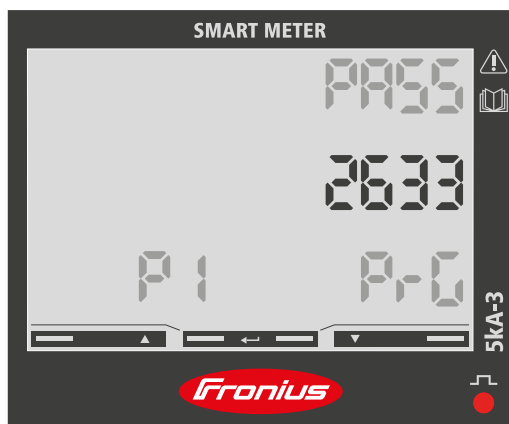

- 1 Press and hold "Enter" for 2 seconds.
- 2 Use "Up" or "Down" to access the P1 screen.
- 3 Set password "2633" with "Up" and "Down" and confirm each individual value with "Enter".
- 4 Note down the password.

IMPORTANT!

The password cannot be reset.

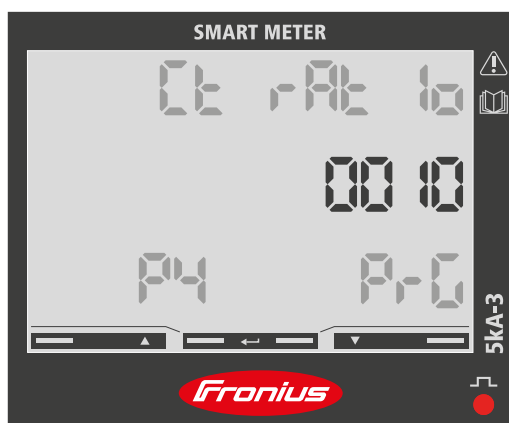

- 1 Use "Up" or "Down" to access the P4 screen.
- 2 Press and hold "Enter" for 2 seconds.
- 3 Set the address with "Up" and "Down" and confirm each individual value with "Enter".
- 4 Press "Up" to access screen P18 and press and hold "Enter" for 2 seconds to exit the settings.

Ratio of current transformers¹⁾ (0001 - 1000²⁾).







Ratio of voltage transformers^{1), 3)} (001.0 - 1000²⁾).

¹⁾**Important!** Changing the transformation ratios will reset the counters in the Fronius Smart Meter TS to 0.

²⁾ Transformation ratio in the current transformer x Transformation ratio of the voltage transformers = max. 1000

³⁾Changeover only when using voltage transformers (direct voltage measurement VT = 1)

Setting the address on the Fronius Smart Meter TS

Symbol	Name	Event	Function
	Up	1 x 	Scroll one screen forward, increase the value by 1
	Down	1 x 	Scroll one screen back, decrease the value by 1
	Enter	2 seconds 	Call up settings, confirm value

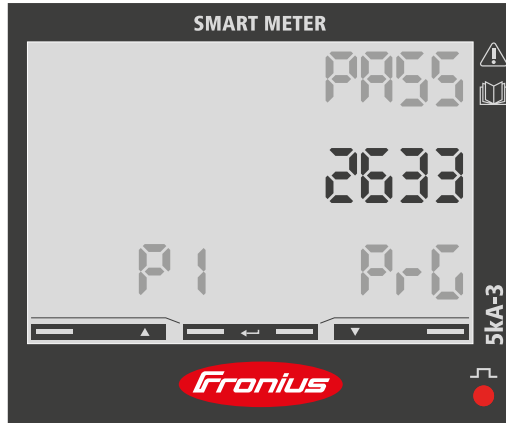

- 1 Press and hold "Enter" for 2 seconds.
- 2 Use "Up" or "Down" to access the P1 screen.
- 3 Set password "2633" with "Up" and "Down" and confirm each individual value with "Enter".

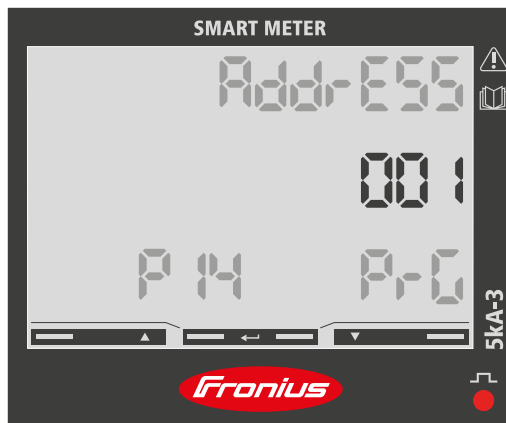

- 1 Use "Up" or "Down" to access the P14 screen.
- 2 Press and hold "Enter" for 2 seconds.
- 3 Set the address with "Up" and "Down" and confirm each individual value with "Enter".
- 4 Press "Up" to access screen P18 and press and hold "Enter" for 2 seconds to exit the settings.

Start-up

General

IMPORTANT! Settings under the "Meter" menu item are only to be made by trained and qualified personnel!

The service password must be entered in order to access the "Meter" menu item.

Three-phase or single-phase Fronius Smart Meter TS can be used. In both cases, the selection is made under the "Fronius Smart Meter" item. The Fronius Datamanager automatically identifies the meter type.

A primary meter and several secondary meters can be selected. The primary meter needs to be configured first before a secondary meter can be selected.

Connecting to the Fronius Datamanager

Access point:

- 5 Connect to the **Fronius_240.XXXXXX** network.
- 6 In the browser address bar, enter and confirm the IP address <http://192.168.250.181> and confirm.

The Fronius Datamanager start page is displayed.

LAN:

- 1 Connect the Fronius Datamanager and computer to a LAN cable.
- 2 Place the Fronius Datamanager IP switch in the 'A' position.
- 3 In the browser address bar, enter and confirm the IP address <http://169.254.0.180> and confirm.

Configuring the Fronius Smart Meter TS as the primary meter

- 1 Go to the Fronius Datamanager website.
 - Open the web browser.
 - In the address bar of the browser, enter the IP address (IP address for WLAN: 192.168.250.181, IP address for LAN: 169.254.0.180) or the host and domain name of the Fronius Datamanager and confirm.
 - The Fronius Datamanager website will be displayed.
- 2 Click the "Settings" button.
- 3 Log in to the login area with the "service" user and the service password.
- 4 Call up the "Meter" menu area.
- 5 Select the primary meter from the drop-down list.
- 6 Click the "Settings" button.
- 7 In the pop-up window, set the position of the meter (feed-in point or consumption point). For more information on the position of the Fronius Smart Meter TS, see [Positioning](#) on page 13.
- 8 Click the "Ok" button when the OK status is displayed. If the *Timeout* status is displayed, try again.
- 9 Click the button to save the settings.

The Fronius Smart Meter TS is configured as a primary meter.

The "Current general view" menu area displays the power of the PV modules, self-consumption, the energy fed into the grid and the battery charge (if available).

**Configuring the
Fronius Smart
Meter TS as a
secondary meter**

- 1** Go to the Fronius Datamanager website.
 - Open the web browser.
 - In the address bar of the browser, enter the IP address (IP address for WLAN: 192.168.250.181, IP address for LAN: 169.254.0.180) or the host and domain name of the Fronius Datamanager and confirm.
 - The Fronius Datamanager website will be displayed.
- 2** Click the "Settings" button.
- 3** Log in to the login area with the "service" user and the service password.
- 4** Call up the "Meter" menu area.
- 5** Select the secondary meter from the drop-down list.
- 6** Click the "Add" button.
- 7** Enter the name of the secondary meter in the "Name" input field.
- 8** Enter the previously assigned address in the "Modbus address" input field.
- 9** Add meter description.
- 10** Click the button to save the settings.

The Fronius Smart Meter TS is configured as a secondary meter.

Fronius GEN24 inverter

General

IMPORTANT! Settings under the "System configuration" menu item are only to be made by trained and qualified personnel!

The service password must be entered in order to access the "System configuration" menu item.

Three-phase or single-phase Fronius Smart Meter TS can be used. In both cases, the selection is made under the "Components" menu area. The meter type is determined automatically.

A primary meter and several secondary meters can be selected. The primary meter needs to be configured first before a secondary meter can be selected.

Installation using the web browser

WLAN:

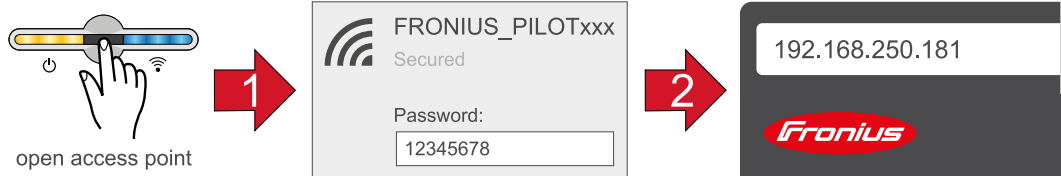

- 1 Open the access point by touching the sensor once → Communication LED: flashes blue.
- 2 Establish the connection to the inverter in the network settings (the inverter is displayed with the name "FRONIUS_PILOT" and the serial number of the device).
- 3 Password: enter 12345678 and confirm.
IMPORTANT!
To enter the password on a Windows 10 operating system, the link "Connect using a security key instead" must first be activated to establish a connection with the password: 12345678.
- 4 In the browser address bar, enter and confirm the IP address 192.168.250.181. The installation wizard is opened.
- 5 Follow the installation wizard in the individual sections and complete the installation.
- 6 Add system components in Solar.web and start up the PV system.

The network wizard and the product setup can be carried out independently of each other. A network connection is required for the Solar.web installation wizard.

Ethernet:

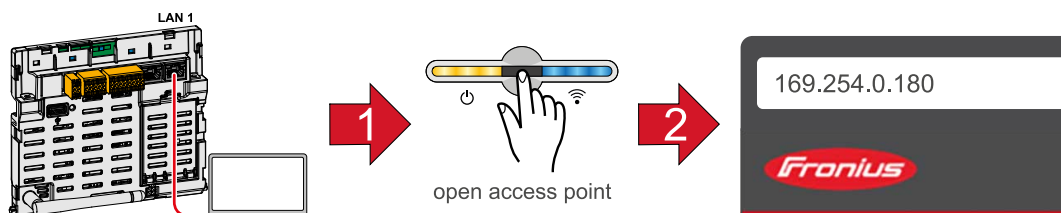

- 1 Establish a connection to the inverter (LAN1) with a network cable (CAT5 STP or higher).

- 2 Open the access point by touching the sensor once  → Communication LED: flashes blue.
- 3 In the browser address bar, enter and confirm IP address 169.254.0.180. The installation wizard is opened.
- 4 Follow the installation wizard in the individual sections and complete the installation.
- 5 Add system components in Solar.web and start up the PV system.

The network wizard and the product setup can be carried out independently of each other. A network connection is required for the Solar.web installation wizard.

Configuring the Fronius Smart Meter TS as the primary meter

- 1 Access the inverter website.
 - Open the web browser.
 - In the address bar of the browser, enter the IP address (IP address for WLAN: 192.168.250.181, IP address for LAN: 169.254.0.180) or the host and domain name of the inverter and confirm.
 - The inverter website is displayed.
- 2 Click the "System configuration" button
- 3 Log in to the login area with the "Technician" user and the technician password.
- 4 Access the "Components" menu area.
- 5 Click the "Add component" button.
- 6 In the "Position" drop-down list, set the position of the meter (feed-in point or consumption point). For more information on the position of the Fronius Smart Meter TS, see [Positioning](#) on page 13.
- 7 Click the "Add" button.
- 8 Click the "Save" button to save the settings.

The Fronius Smart Meter TS is configured as a primary meter.

Configuring the Fronius Smart Meter TS as a secondary meter

- 1 Access the inverter website.
 - Open the web browser.
 - In the address bar of the browser, enter the IP address (IP address for WLAN: 192.168.250.181, IP address for LAN: 169.254.0.180) or the host and domain name of the inverter and confirm.
 - The inverter website is displayed.
- 2 Click the "System configuration" button
- 3 Log in to the login area with the "Technician" user and the technician password.
- 4 Access the "Components" menu area.
- 5 Click the "Add component" button.
- 6 In the "Position" drop-down list, select the meter type (producer/load meter).
- 7 Enter the previously assigned address in the "Modbus address" input field.
- 8 Enter the name of the meter in the "Name" input field.
- 9 In the "Category" drop-down list, select the category (producer or load).
- 10 Click the "Add" button.
- 11 Click the "Save" button to save the settings.

The Fronius Smart Meter TS is configured as a secondary meter.

Technical data

Technical data

Modbus transmission speed: 9600 baud

Parity bit: none

Software version:

- Fronius Datamanager 2.0 (from version 3.16.1 onwards)
- Fronius Symo Hybrid (from version 1.16.1 onwards)

Measuring input	
Three-phase nominal voltage Operating range	400 - 480 V (-20% to +15%) 400 - 173 VLL ± (2% RDG/accuracy)
Single-phase nominal voltage Operating range	230 - 277 V (-20% to +15%) 100 - 230 VLN ± (1% RDG/accuracy)
Voltage transformer ratio (kVT)	1 - 1000 e. g. VT 20000/400V kVT = 50 for direct connection: kVT = 1
Self-consumption - voltage path (max. voltage)	10 VA
Nominal frequency Tolerance	50 - 60 Hz 45 - 65 Hz
Nominal current, I_b	1 A + 5 A
Maximum current, I_{max}	6 A
Starting current	10 mA
Current transformer ratio (kCT)	1 - 1000 e. g. TC 800/5A kCT = 160 for direct connection: kCT = 1
Short-time overload (EN IEC 62053-21, EN IEC 62053-23)	$5 I_{max} / 0.5 \text{ s}$
Self-consumption - current path (max. current)	0.3 W per phase
Maximum value kVT x kCT	1000 (CT/5A)
Current distortion factor	in acc. with EN IEC 62053-21
Power factor Operating range (EN IEC 62053-21, EN IEC 62053-23)	active $\cos\phi$ 0.5 ind - 0.8 cap, reactive $\sin\phi$ 0.5 ind - 0.5 cap

Energy	
Max. display	As per table
Resolution	As per table
LED indicator	1 pulse / 0.1 Wh
Active energy accuracy (EN IEC 62053-21)	Class 1 Class 2: 100 - 230 VLN (173 - 400 VLL)
Reactive energy accuracy (EN IEC 62053-23)	Class 2

Energy	
Response time after switch-on (EN IEC 62053-21, EN IEC 62053-23)	< 5 s

kCT x kVT	Maximum display		Resolution
1 - 9.9	9 9 9 9 9 9 . 9 9	kWh / kvarh	10 Wh / varh
10 - 99.9	9 9 9 9 9 9 9 . 9	kWh / kvarh	100 Wh / varh
100 - 999.9	9 9 9 9 9 9 9 9	kWh / kvarh	1 kWh / varh
≥ 1000	9 9 9 9 9 9 . 9 9	MWh / kvarh	10 kWh / varh

Average power	
Measured variable	Effective power
Calculation	Average value over set period of time
Integration time	5 / 8 / 10 / 15 / 20 / 30 / 60 minutes

Output	
RS485 communication Electrically isolated from input and auxiliary voltage	
Standard	RS485 - 3 conductors
Transmission	Serial, asynchronous
Protocol	Modbus RTU
Addresses	1 - 255
Number of bits	8
Stop bit	1
Parity bit	None - even - odd
Baud rate	9600, 19200, 38400 bit/s
Response time	≤ 200 ms

Insulation (EN IEC 62052-11, EN IEC 62053-21)	
Installation category	III
Pollution degree	2
Insulation voltage	4 kV RMS
Impulse withstand voltage Test circuit	4 kV 1.2/60 μs Voltage input, current input, pulse output, communication
Test voltage Test circuit	2.75 kV RMS. 50 Hz/1 min Voltage input, current input, pulse output, communication
Test voltage Test circuit	4 kV RMS. 50 Hz/1 min All circuits and earth

Electromagnetic compatibility	
Test in acc. with EN IEC 62052-11	

Operating conditions	
Reference temperature	25 °C (± 5 °C)
Operating range	-25 to +65 °C
Temperature limit for storage and transport	-30 to +80 °C
Max. power loss (for thermal dimensioning of the switch cabinet)	≤ 2.8 W

Housing	
Housing	3 modules according to DIN 43880
Sealable housing/terminal cover	
Connection	Screw connection
Mounting	Can be snapped onto 35 mm DIN rail
Housing material	Noryl, self-extinguishing
Degree of protection (EN 60529)	IP54 housing, IP20 connections
Weight	240 grams

Terminals	
Measuring input	
Wire	Min. 1 mm ² / max. 4 mm ²
Recommended torque	max. 0.6 Nm

Data output	
Wire	min 0.05 mm ²
Recommended torque	max. 0.4 Nm

Fronius manufacturer's warranty

Detailed, country-specific warranty terms are available on the internet:
www.fronius.com/solar/warranty

To obtain the full warranty period for your newly installed Fronius inverter or storage system, please register at: www.solarweb.com.

FRONIUS INTERNATIONAL GMBH

Froniusstraße 1
A-4643 Pettenbach
AUSTRIA
contact@fronius.com
www.fronius.com

Under **www.fronius.com/contact** you will find the addresses
of all Fronius Sales & Service Partners and locations



Find your
spareparts online



spareparts.fronius.com